



**100% ARTIGIANALITÀ**  
**100% MADE IN ITALY**

Il Gruppo Giordano opera da venticinque anni al servizio del cliente. Un lungo percorso di successi ha trasformato la nostra bottega artigiana in un'industria all'avanguardia nella produzione di serramenti e porte. Dalla forte esperienza acquisita negli anni, unita all'utilizzo di macchine all'avanguardia, nascono prodotti di eccellenza.

The Giordano Group has been serving customers for twenty-five years. A long path of success has transformed our artisan workshop into a cutting-edge industry in the production of windows and doors. From the strong experience acquired over the years, combined with the use of cutting-edge machines, products of excellence are born.



## **Tradizione e innovazione**

Il nostro punto di forza è quello di fondere l'utilizzo di macchine a controllo digitale con la capacità artigianale che vanta una tradizione pluridecennale. Il risultato è un prodotto che soddisfa le richieste di una clientela sempre più attenta all'estetica e alla qualità, per garantisce ottime prestazioni sia in termini di resistenza meccanica che di isolamento termico. La qualità è garantita dalle certificazioni rilasciate su tutte le linee

## **Tradition and innovation**

Our strength is to merge the use of digitally controlled machines with the craftsmanship it boasts a decades-long tradition. The result is a product that meets the demands of customers who are increasingly attentive to aesthetics and quality, to ensure excellent performance both in terms of mechanical strength and thermal insulation. The quality is guaranteed by the certifications issued on all lines.











LAMINATE



## MODELLO COMBI

ASSIEME STIPITE + COPRI FILO SEMI-COMPLANARE

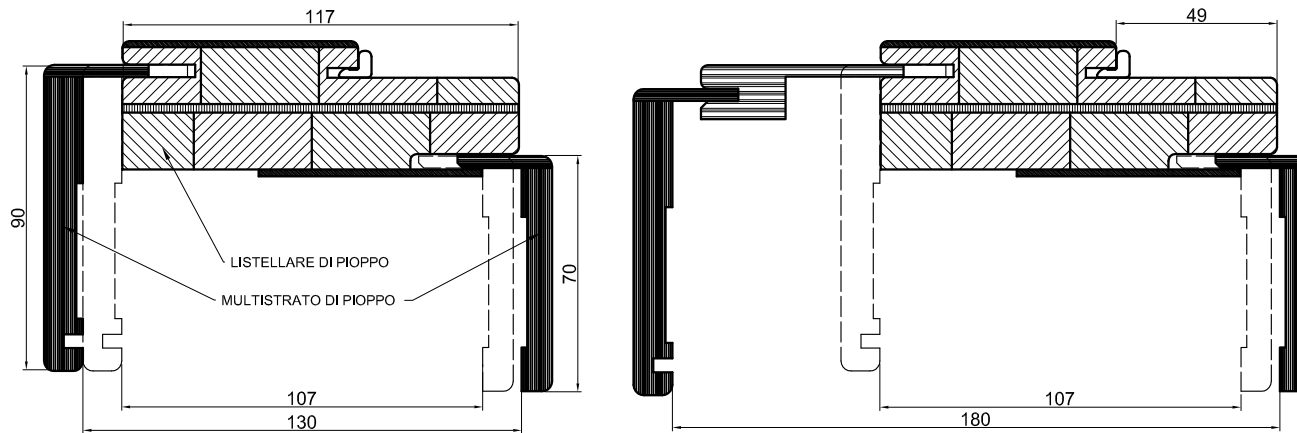

## MODELLO A FILO

ASSIEME STIPITE + COPRI FILO COMPLANARE

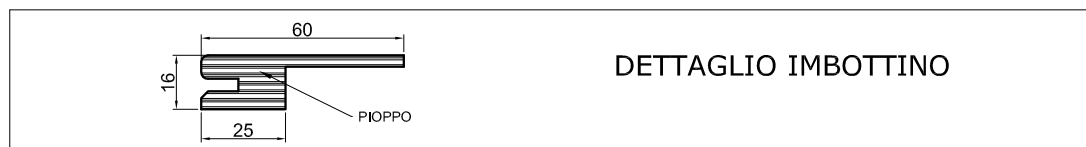
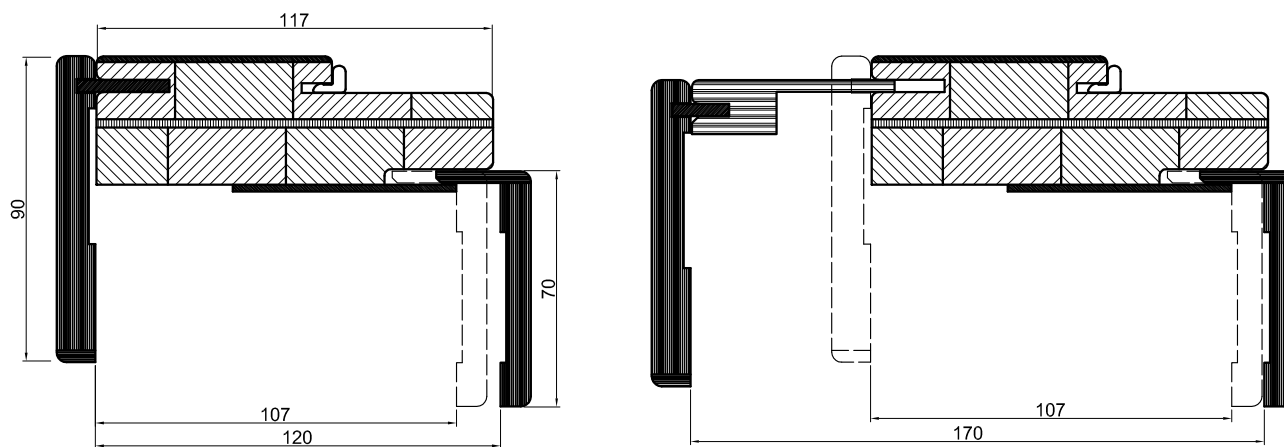

PANNELLI DISPONIBILI	cm60	cm70	cm80	cm90
DISPONIBILI ANCHE NELLA VERSIONE SCORREVOLE INTERNO/ESTERNO MURO				

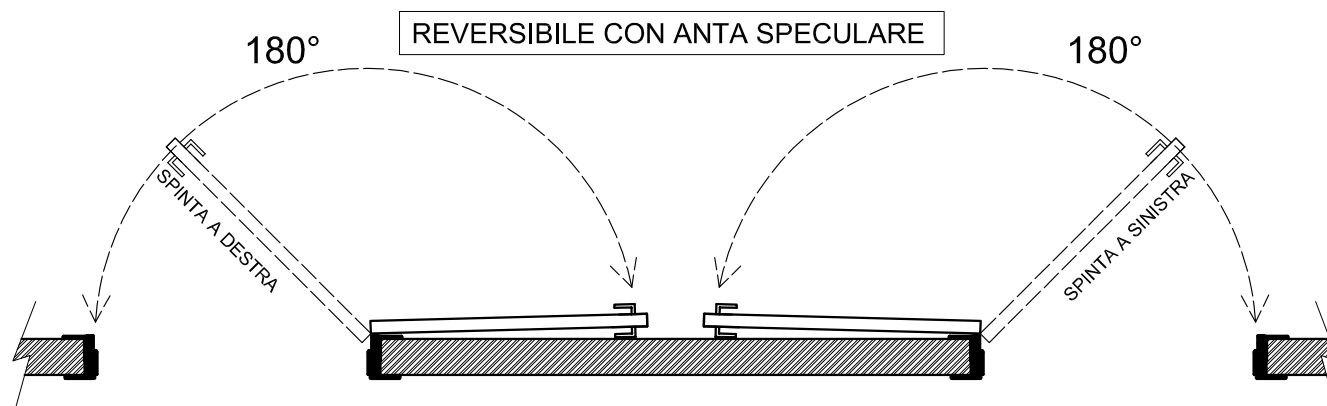



# MODELLO STANDARD DI SERIE

## TELAI

Frames / Cadres

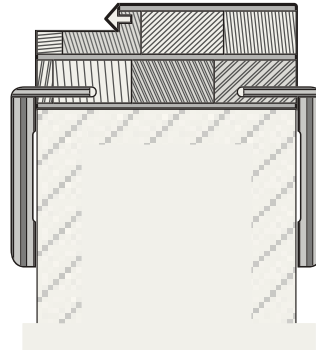

Telaio Spigolo con guarnizione  
Frame Spigolo with gasket  
Cadre Spigolo avec garniture

## ALLARGAMENTI

Frame extension / Cadre extension

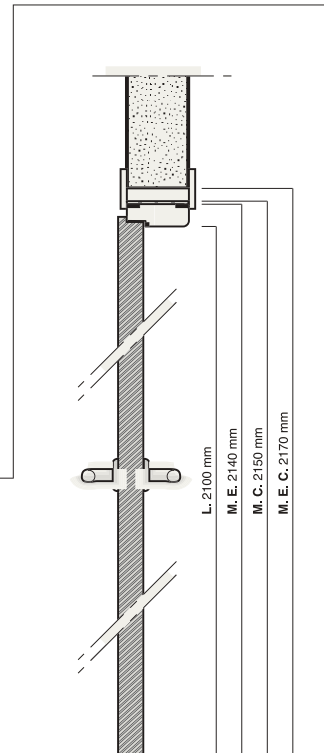
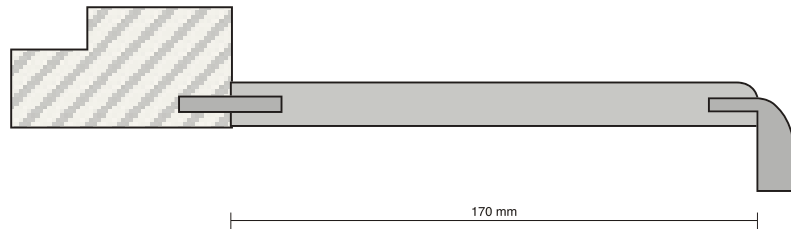

## INGOMBRI

Dimensions / Dimensions

L. = Luce netta  
M. E. = Misura esterna telaio  
M. C. = Misura luce netta controtelaio  
M. E. C. = Misura esterna controtelaio

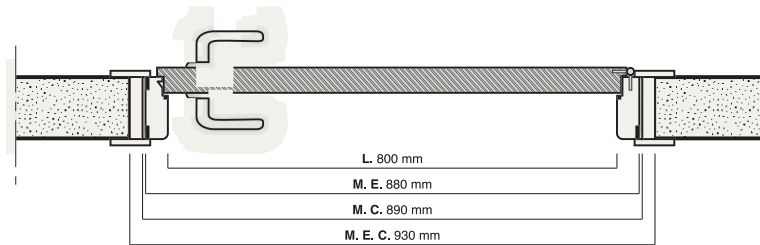

## SENSI DI APERTURA

Opening directions / Ouverture de la porte

Porta ad un'anta battente  
Beating single leaf  
Porte à battant

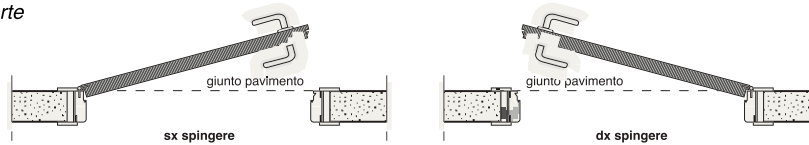

Porta a libro  
Folding door  
Porte coulissante

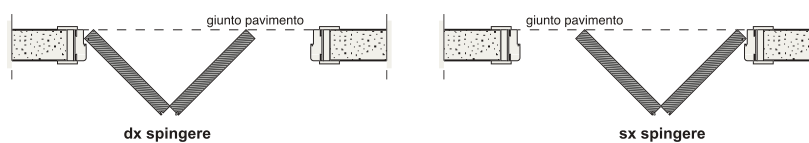



## MOD. ADA



Palissandro bianco  
Matrix 2302



Noce Alter  
LK48



Larice Sabbia  
1105



Olmo Cenere

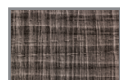

Tranchè  
LM93



## MOD. AIDA



Palissandro bianco  
Matrix 2302



Noce Alter  
LK48



Larice Sabbia  
1105



Olmo Cenere



Tranchè  
LM93





## MOD. BARBARA



Palissandro bianco  
Matrix 2302



Noce Alter  
LK48



Larice Sabbia  
1105



Olmo Cenere

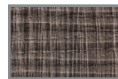

Tranchè  
LM93



## MOD. ALTEA



Palissandro bianco  
Matrix 2302



Noce Alter  
LK48



Larice Sabbia  
1105



Olmo Cenere

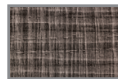

Tranchè  
LM93





## MOD. TOSCA



Palissandro bianco  
Matrix 2302



Noce Alter  
LK48



Larice Sabbia  
1105



Olmo Cenere



Tranchè  
LM93



## MOD. ALICE

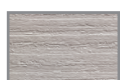

Palissandro bianco  
Matrix 2302



Noce Alter  
LK48



Larice Sabbia  
1105



Olmo Cenere



Tranchè  
LM93



Ciliegio  
LC 69





MOD. GRETA



Palissandro bianco  
Matrix 2302



Noce Alter  
LK48



Larice Sabbia  
1105



Olmo Cenere



Tranchè  
LM93





## MOD. SILVIA



Palissandro bianco  
Matrix 2302



Noce Alter  
LK48



Larice Sabbia  
1105



Olmo Cenere



Tranchè  
LM93



## MOD. ALBA



Palissandro bianco  
Matrix 2302



Noce Alter  
LK48



Larice Sabbia  
1105



Olmo Cenere

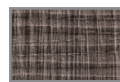

Tranchè  
LM93





## MOD. ROMA PALISSANDRO



Palissandro bianco  
Matrix 2302



Noce Alter  
LK48



Larice Sabbia  
1105



Olmo Cenere



Tranchè  
LM93

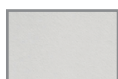

Bianco  
B011

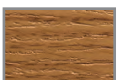

Rovere  
LK82



Bianco  
Matrix



## MOD. GIULIA TREND "R3"



Palissandro bianco  
Matrix 2302



Noce Alter  
LK48



Larice Sabbia  
1105



Olmo Cenere



Tranchè  
LM93

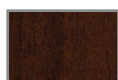

Noce  
840



Ciliegio  
LD46



Tanganica  
LD57





## MOD. ROMA BIANCA



Bianco  
B011



## MOD. FELICIA



Tanganica  
LD57



Noce  
840



Ciliegio  
LD 46







MOD. INGRID



Palissandro bianco  
Matrix 2302



Noce Alter  
LK48



Larice Sabbia  
1105

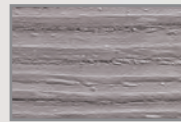

Olmo Cenere

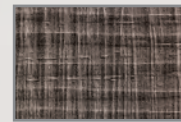

Tranchè  
LM93





## MOD. ROMA



Palissandro bianco  
Matrix 2302



Rovere sbiancato



Larice Sabbia  
1105



Olmo Cenere



Tranchè  
LM93

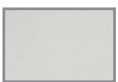

Bianco  
B011



Rovere  
LK82



Bianco  
Matrix



## MOD. AURORA VETRO



Palissandro bianco  
Matrix 2302



Noce Alter  
LK48



Larice Sabbia  
1105



Olmo Cenere



Tranchè  
LM93





## MOD. ROMA 2 INSERTI



Palissandro bianco  
Matrix 2302



Noce Alter  
LK48



Larice Sabbia  
1105



Olmo Cenere

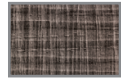

Tranchè  
LM93



Bianco  
B011



Rovere  
LK82



Bianco  
Matrix



## MOD. ROMA 4 INSERTI



Palissandro bianco  
Matrix 2302



Noce Alter  
LK48



Larice Sabbia  
1105



Olmo Cenere

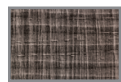

Tranchè  
LM93



Bianco  
B011



Rovere  
LK82



Bianco  
Matrix





MOD. GIULIA BUGNATA

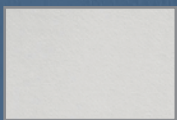

Bianco  
B011



Noce  
840



Ciliegio  
LD 46

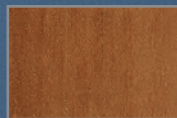

Tanganica  
LD57





## MOD. MOANA



Palissandro bianco  
Matrix 2302



Noce Alter  
LK48



Larice Sabbia  
1105



Olmo Cenere



Tranchè  
LM93



## MOD. SOFIA



Palissandro bianco  
Matrix 2302



Noce Alter  
LK48



Larice Sabbia  
1105



Olmo Cenere



Tranchè  
LM93





## MOD. BRIGITTE TRANDY



Palissandro bianco  
Matrix 2302



Noce Alter  
LK48



Larice Sabbia  
1105



Olmo Cenere



Tranchè  
LM93

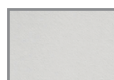

Bianco  
B011

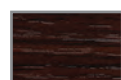

Wenge  
LD55



Bianco  
Matrix



## MOD. MOANA VETRO



Palissandro bianco  
Matrix 2302



Noce Alter  
LK48



Larice Sabbia  
1105



Olmo Cenere



Tranchè  
LM93





## MOD. JESSICA



Palissandro bianco  
Matrix 2302



Noce Alter  
LK48



Larice Sabbia  
1105



Olmo Cenere



Tranchè  
LM93



Bianco  
B011



Wenge  
LD55



Bianco  
Matrix



## MOD. GIULIA RIO

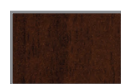

Noce  
840



Ciliegio  
LD 46



Tanganica  
LD57





MOD. ROMA



Palissandro bianco  
Matrix 2302



Noce Alter  
LK48



Larice Sabbia  
1105



Olmo Cenere

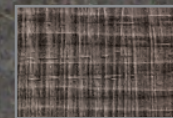

Tranchè  
LM93

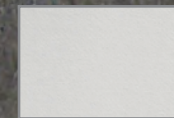

Bianco  
B011



Rovere  
LK82



Bianco  
Matrix

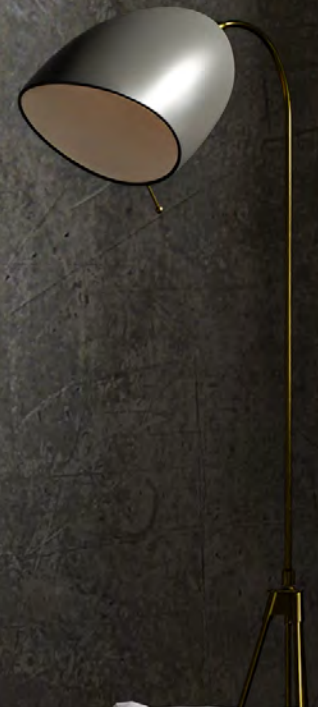



## MOD. EVA



Palissandro bianco  
Matrix 2302



Noce Alter  
LK48



Larice Sabbia  
1105



Olmo Cenere

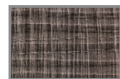

Tranchè  
LM93

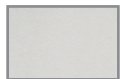

Bianco  
B011



Wenge  
LD55



Bianco  
Matrix



Ciliegio  
LD 46



Tanganica  
LD57



Noce  
840



## MOD. CLARISSA



Palissandro bianco  
Matrix 2302



Noce Alter  
LK48



Larice Sabbia  
1105



Olmo Cenere



Tranchè  
LM93

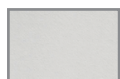

Bianco  
B011

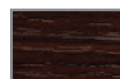

Wenge  
LD55



Bianco  
Matrix



Ciliegio  
LD 46



Tanganica  
LD57



Noce  
840







Cerniera a scomparsa  
Concealed hinge

Su richiesta  
On request



Serratura magnetica  
Magnetic lock

Su richiesta  
On request





Cerniera Anuba  
Anuba hinge



Cerniera a scomparsa  
Concealed hinge





# LE ESSENZE E I COLORI

## THE ESSENCES AND COLORS

### OPACO

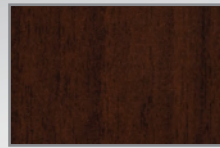

Noce  
840

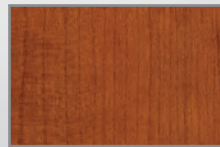

Ciliegio  
LD 46

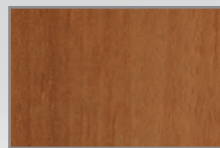

Tanganica  
LD57

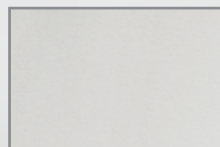

Bianco  
BO11

### PORO



Wenge  
LD55



Ciliegio  
LG 69



Rovere  
LK82



Rovere  
sbiancato

### TREND



Palissandro  
bianco  
Matrix 2302



Palissandro  
LK55



Bianco  
Matrix



Bianco  
Azimut  
BO73

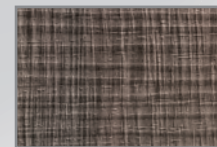

Tranchè  
LM93

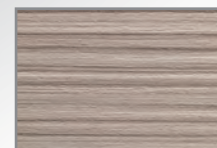

Larice Sabbia  
1105

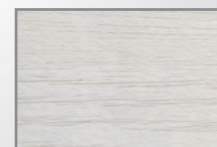

Bianco  
Olmo



Olmo Cenere



Noce Alter  
LK48



*PORTA FILOMURO  
FLUSH DOOR*



Telaio alluminio  
Pannello porta si può avere:  
Grezzo  
Laccato  
Laccato solo di preparazione

Aluminum frame  
Door panel can be obtained:  
Rough  
Lacquered  
Lacquered only for preparation

Disponibile in: Tutti i colori RAL

Available in: All RAL colors

Disponibile anche in versione scorrevole interno muro  
Also available in internal wall sliding version



The image features a central white rectangular box with a thin black border containing the word "PANTOGRAFATE" in a black, uppercase, sans-serif font. The background is a light beige color with a subtle, repeating pattern of stylized palm fronds in a light grey tone, creating a textured, organic feel.

PANTOGRAFATE



MOD. REBECCA

**Disponibile in:**  
tutti i colori RAL

**Available in:**  
all RAL colors





MOD. AGATA

**Disponibile in:**  
tutti i colori RAL

**Available in:**  
all RAL colors





MOD. FRIDA

Frassino laccato

**Disponibile in:**  
tutti i colori RAL

Lacquered ash

**Available in:**  
all RAL colors





MOD. OXFORD

**Disponibile in:**  
tutti i colori RAL

**Available in:**  
all RAL colors







MOD. CLELIA

Frassino laccato    Lacquered ash

**Disponibile in:**  
tutti i colori RAL

**Available in:**  
all RAL colors



MOD. ARTEMISIA

**Disponibile in:**  
tutti i colori RAL

**Available in:**  
all RAL colors





MOD. NATHAN

**Disponibile in:**  
tutti i colori RAL

**Available in:**  
all RAL colors

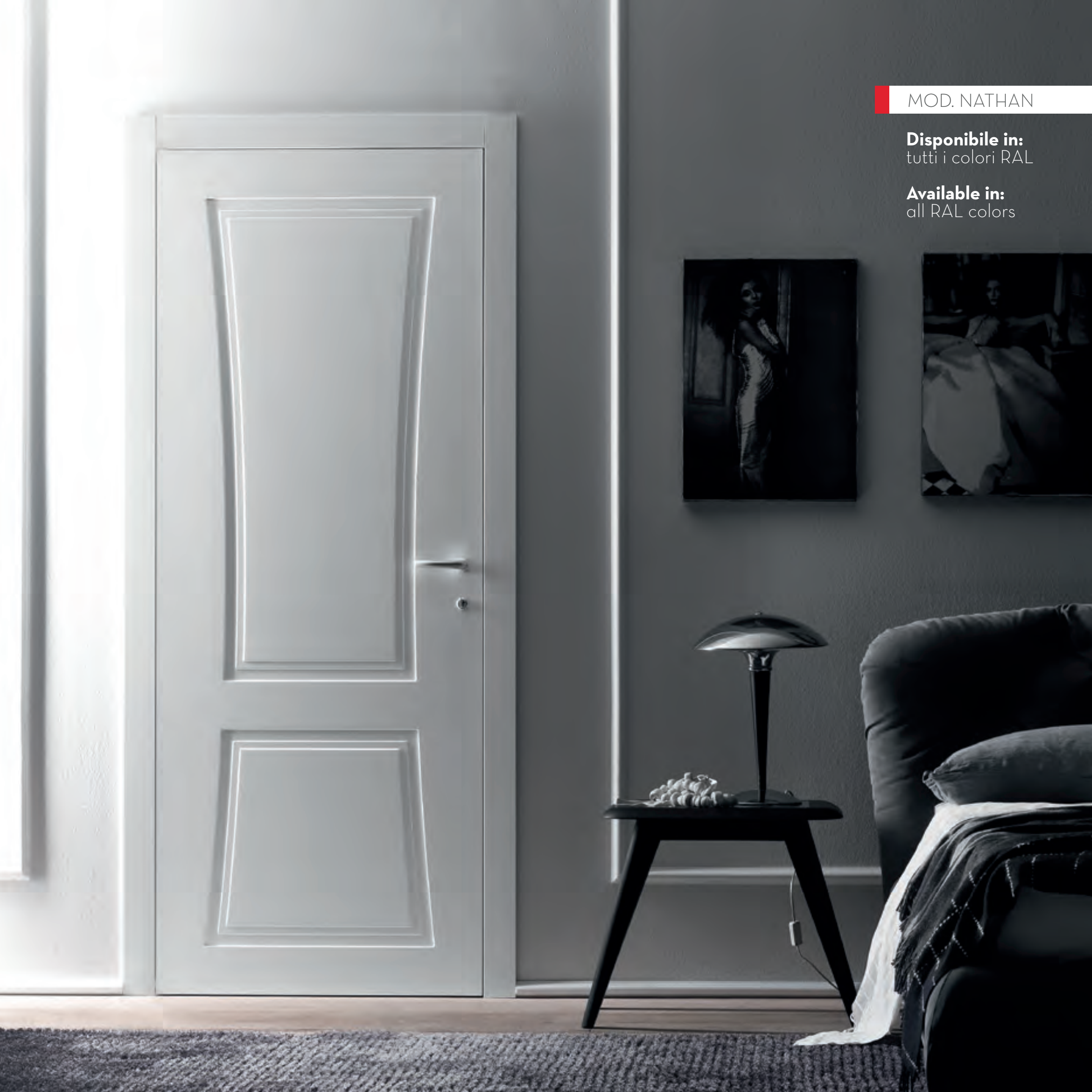



## MOD. EVEN

Frassino laccato

**Disponibile in:**  
tutti i colori RAL

Lacquered ash

**Available in:**  
all RAL colors



## MOD. SOFIA

Frassino laccato

**Disponibile in:**  
tutti i colori RAL

Lacquered ash

**Available in:**  
all RAL colors





## MOD. AMBRA

Frassino laccato  
spazzolato bianco tenue

**Disponibile in:**  
tutti i colori RAL

Lacquered ash  
soft white brushed

**Available in:**  
all RAL colors



## MOD. CAMELIA

Frassino grigio chiaro  
a poro aperto

**Disponibile in:**  
tutti i colori RAL

Light gray ash  
open pore

**Available in:**  
all RAL colors





## MOD. DIANA

Frassino laccato  
spazzolato bianco tenue

**Disponibile in:**  
tutti i colori RAL

Lacquered ash  
soft white brushed

**Available in:**  
all RAL colors



## MOD. ELENA

Frassino avorio a  
poro aperto

**Disponibile in:**  
tutti i colori RAL

Ivory ash a  
open pore

**Available in:**  
all RAL colors





## MOD. NAPOLI

Laccato bianco

**Disponibile in:**  
tutti i colori RAL

White lacquered

**Available in:**  
all RAL colors



## MOD. HAILA

Laccato bianco

**Disponibile in:**  
tutti i colori RAL

White lacquered

**Available in:**  
all RAL colors





MOD. P-03

Laccato

**Disponibile in:**  
tutti i colori RAL

Lacquered

**Available in:**  
all RAL colors





## MOD. OLIMPIA

Laccato bianco

**Disponibile in:**  
tutti i colori RAL

White lacquered

**Available in:**  
all RAL colors



## MOD. OLIMPIA VETRO

Laccato bianco

**Disponibile in:**  
tutti i colori RAL

White lacquered

**Available in:**  
all RAL colors





## MOD. NOA

Laccato bianco

**Disponibile in:**  
tutti i colori RAL

White lacquered

**Available in:**  
all RAL colors



## MOD. ITALO

Laccato bianco

**Disponibile in:**  
tutti i colori RAL

White lacquered

**Available in:**  
all RAL colors





# PANTAGROFATURE STANDARD

## Curva



• **Poro chiuso** con pantografatura modello *Squadro, Curva, Scala*. Pannello in HDF 8mm tangananacia telaio e coprifili impiallacciati tangananacia

• **Closed pore** with model pantograph *Square or Curve or scake*. 8mm HDF panel tangananacia frame and veneered casings tangananacia

## Squadro



• **Poro aperto** con pantografatura modello *Squadro*. Pannello impiallacciato rovere su HDF telaio e coprifili impiallacciati rovere

• **Open pore** with pattern pantograph *Squad*. Oak veneered panel on HDF frame and veneered architraves oak

## Scala



# PANTAGROFATURE SU RICHIESTA

## P-C



## P-A



## P-B



• **Poro chiuso** con pantografatura modello *Squadro o Curva*. Pannello in HDF 8mm tangananacia telaio e coprifili impiallacciati tangananacia

• **Closed pore** with model pantograph *Square or Curve*. 8mm HDF panel tangananacia frame and veneered casings tangananacia





INCISE



## MOD. ALMA

**Disponibile in:**  
tutti i colori RAL

**Disponibile in:**  
• Rovere poro aperto  
• Tanganica poro chiuso  
colorazioni e dettagli consultare  
la cartella colori

**Available in:**  
all RAL colors

**Available in:**  
• Open pore oak  
• Tanganyika closed pore  
colors and details consult  
the color chart



## MOD. AVOLA

**Disponibile in:**  
tutti i colori RAL

**Disponibile in:**  
• Rovere poro aperto  
• Tanganica poro chiuso  
colorazioni e dettagli consultare  
la cartella colori

**Available in:**  
all RAL colors

**Available in:**  
• Open pore oak  
• Tanganyika closed pore  
colors and details consult  
the color chart





## MOD. DUE ONDE

**Disponibile in:**  
tutti i colori RAL

**Disponibile in:**

- Rovere poro aperto
- Tanganica poro chiuso

colorazioni e dettagli consultare la cartella colori

**Available in:**  
all RAL colors

**Available in:**

- Open pore oak
- Tanganyika closed pore

colors and details consult the color chart



## MOD. VICTORIA

**Disponibile in:**  
tutti i colori RAL

**Disponibile in:**

- Rovere poro aperto
- Tanganica poro chiuso

colorazioni e dettagli consultare la cartella colori

**Available in:**  
all RAL colors

**Available in:**

- Open pore oak
- Tanganyika closed pore

colors and details consult the color chart





## MOD. DIAGONAL

**Disponibile in:**  
tutti i colori RAL

**Disponibile in:**

- Rovere poro aperto
- Tanganica poro chiuso

colorazioni e dettagli consultare la cartella colori

**Available in:**  
all RAL colors

**Available in:**

- Open pore oak
- Tanganyika closed pore

colors and details consult the color chart



## MOD. 3 LINE

**Disponibile in:**  
tutti i colori RAL

**Disponibile in:**

- Rovere poro aperto
- Tanganica poro chiuso

colorazioni e dettagli consultare la cartella colori

**Available in:**  
all RAL colors

**Available in:**

- Open pore oak
- Tanganyika closed pore

colors and details consult the color chart





MOD. SYLVIA

**Disponibile in:**  
tutti i colori RAL

**Disponibile in:**

- Rovere poro aperto
- Tanganica poro chiuso

colorazioni e dettagli consultare la cartella colori

**Available in:**  
all RAL colors

**Available in:**

- Open pore oak
- Tanganyika closed pore

colors and details consult the color chart





## MOD. BOOMER

**Disponibile in:**  
tutti i colori RAL

**Disponibile in:**

- Rovere poro aperto
- Tanganica poro chiuso

colorazioni e dettagli consultare la cartella colori

**Available in:**  
all RAL colors

**Available in:**

- Open pore oak
- Tanganyika closed pore

colors and details consult the color chart



## MOD. TESSA

**Disponibile in:**  
tutti i colori RAL

**Disponibile in:**

- Rovere poro aperto
- Tanganica poro chiuso

colorazioni e dettagli consultare la cartella colori

**Available in:**  
all RAL colors

**Available in:**

- Open pore oak
- Tanganyika closed pore

colors and details consult the color chart





## MOD. IVONA

**Disponibile in:**  
tutti i colori RAL

**Disponibile in:**  
• Rovere poro aperto  
• Tanganica poro chiuso  
colorazioni e dettagli consultare  
la cartella colori

**Available in:**  
all RAL colors

**Available in:**  
• Open pore oak  
• Tanganyika closed pore  
colors and details consult  
the color chart



## MOD. MONDRIAN

**Disponibile in:**  
tutti i colori RAL

**Disponibile in:**  
• Rovere poro aperto  
• Tanganica poro chiuso  
colorazioni e dettagli consultare  
la cartella colori

**Available in:**  
all RAL colors

**Available in:**  
• Open pore oak  
• Tanganyika closed pore  
colors and details consult  
the color chart





## MOD. 3 LINE V

**Disponibile in:**  
tutti i colori RAL

**Disponibile in:**

- Rovere poro aperto
- Tanganica poro chiuso

colorazioni e dettagli consultare la cartella colori

**Available in:**  
all RAL colors

**Available in:**

- Open pore oak
- Tanganyika closed pore

colors and details consult the color chart



## MOD. 4H LINE

**Disponibile in:**  
tutti i colori RAL

**Disponibile in:**

- Rovere poro aperto
- Tanganica poro chiuso

colorazioni e dettagli consultare la cartella colori

**Available in:**  
all RAL colors

**Available in:**

- Open pore oak
- Tanganyika closed pore

colors and details consult the color chart





MOD. ONDA

**Disponibile in:**  
tutti i colori RAL

**Disponibile in:**

- Rovere poro aperto
- Tanganica poro chiuso

colorazioni e dettagli consultare la cartella colori

**Available in:**  
all RAL colors

**Available in:**

- Open pore oak
- Tanganyika closed pore

colors and details consult the color chart

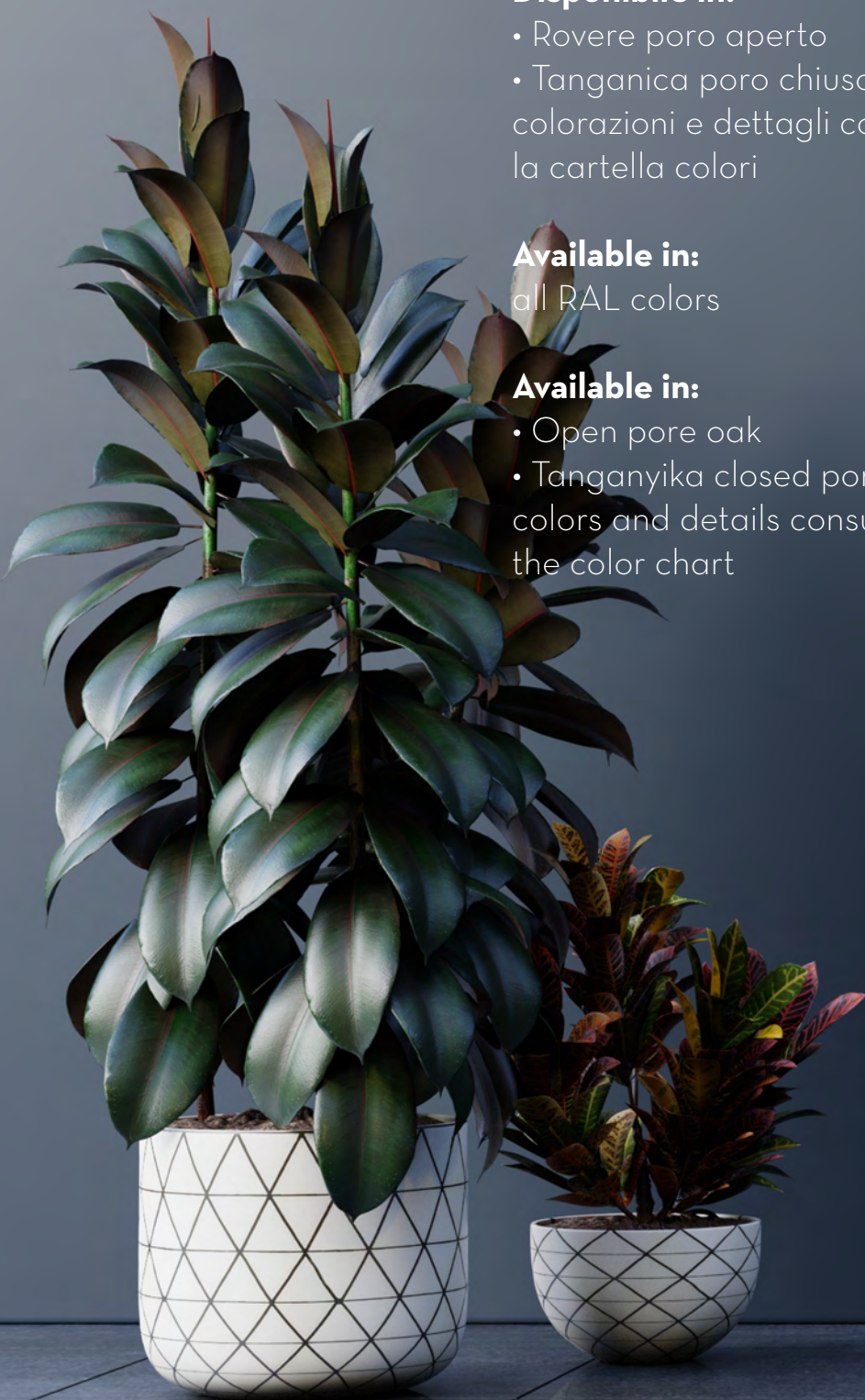



# PANTAGROFATURE STANDARD

**P-M**



**Disponibile in:**

- Rovere poro aperto
  - Tanganica poro chiuso
- colorazioni e dettagli consultare la cartella colori

**P-G**



**Available in:**

- Open pore oak
  - Tanganyika closed pore
- colors and details consult the color chart



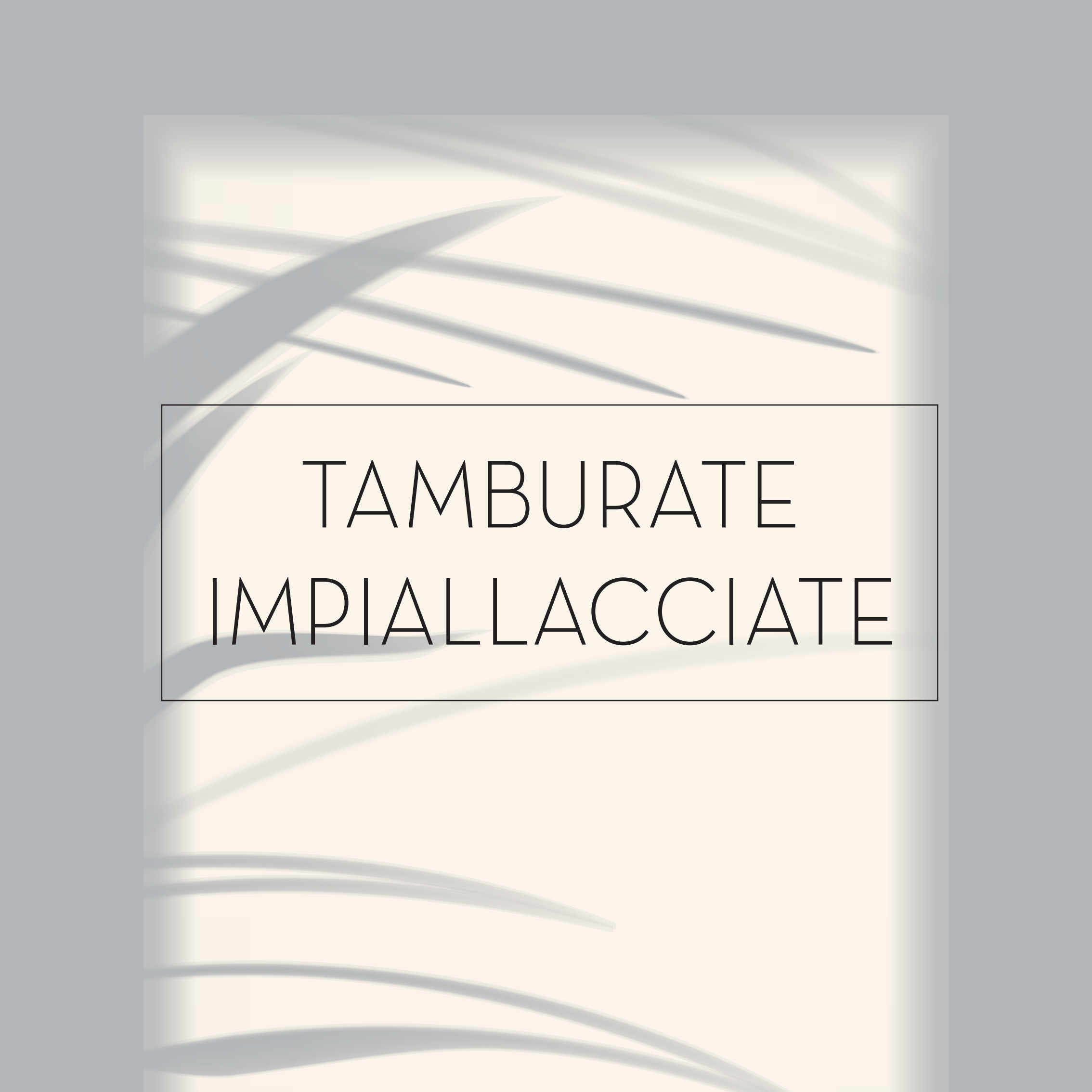

TAMBURATE  
IMPIALLACCIATE



## MOD. TEO

Rovere

### Disponibile in:

Rovere, Tanganica  
Colorazioni e dettagli consultare  
la cartella colori

Oak

### Available in:

Oak, Tanganyika  
Colors and details consult  
the color chart



## MOD. LEILA

Rovere

### Disponibile in:

Rovere, Tanganica  
Colorazioni e dettagli consultare  
la cartella colori

Oak

### Available in:

Oak, Tanganyika  
Colors and details consult  
the color chart





## MOD. GIADA VETRO

Tanganica Tinta Noce

### **Disponibile in:**

Rovere, Tanganica  
Colorazioni e dettagli consultare  
la cartella colori

Tanganyika Tinted Walnut

### **Available in:**

Oak, Tanganyika  
Colors and details consult  
the color chart



## MOD. GIADA

Tanganica Tinta Noce

### **Disponibile in:**

Rovere, Tanganica  
Colorazioni e dettagli consultare  
la cartella colori

Tanganyika Tinted Walnut

### **Available in:**

Oak, Tanganyika  
Colors and details consult  
the color chart





## MOD. GIADA DOPPIO VETRO

Tanganica Tinta Noce

### **Disponibile in:**

Rovere, Tanganica  
Colorazioni e dettagli consultare  
la cartella colori

Tanganyika Tinted Walnut

### **Available in:**

Oak, Tanganyika  
Colors and details consult  
the color chart



## MOD. ASTERIA VETRO

Tanganica Tinta Ciliegio

### **Disponibile in:**

Rovere, Tanganica  
Colorazioni e dettagli consultare  
la cartella colori

Tanganyika Cherry Tint

### **Available in:**

Oak, Tanganyika  
Colors and details consult  
the color chart







## MOD. MUSA

Rovere

### **Disponibile in:**

Rovere, Tanganica  
Colorazioni e dettagli  
consultare la cartella colori

Oak

Available in:

Oak, Tanganyika, Ash  
Colors and details  
consult the color chart





MOD. AMBRA  
DOPPIO VETRO

Tanganica Tinta Ciliegio

**Disponibile in:**

Rovere, Tanganica  
Colorazioni e dettagli consultare  
la cartella colori

Tanganyika Cherry Tint

**Available in:**

Oak, Tanganyika  
Colors and details consult  
the color chart



MOD. AMBRA VETRO

Tanganica Tinta Ciliegio

**Disponibile in:**

Rovere, Tanganica  
Colorazioni e dettagli consultare  
la cartella colori

Tanganyika Cherry Tint

**Available in:**

Oak, Tanganyika  
Colors and details consult  
the color chart





## MOD. AMBRA

Tanganica Tinta Ciliegio

**Disponibile in:**

Rovere, Tanganica  
Colorazioni e dettagli consultare  
la cartella colori

Tanganyika Cherry Tint

**Available in:**

Oak, Tanganyika  
Colors and details consult  
the color chart



## MOD. ASTERIA

Tanganica Tinta Ciliegio

**Disponibile in:**

Rovere, Tanganica  
Colorazioni e dettagli consultare  
la cartella colori

Tanganyika Cherry Tint

**Available in:**

Oak, Tanganyika  
Colors and details consult  
the color chart







MASSELLO



## MOD. AMETISTA

Frassino noce bruno

### Disponibile in:

Frassino, Rovere, Castagno,  
Toulipier  
Colorazioni e dettagli consultare  
la cartella colori

Brown walnut ash

### Available in:

Ash, Oak, Chestnut,  
Toulipier  
Colors and details consult  
the color chart



## PROFILI - PROFILES



A



B



C



## MOD. DAISY

Frassino noce bruno

### **Disponibile in:**

Frassino, Rovere, Castagno,  
Toulipier  
Colorazioni e dettagli consultare  
la cartella colori

Brown walnut ash

### **Available in:**

Ash, Oak, Chestnut,  
Toulipier  
Colors and details consult  
the color chart



## MOD. FLAVIA

Frassino noce bruno

### **Disponibile in:**

Frassino, Rovere, Castagno,  
Toulipier  
Colorazioni e dettagli consultare  
la cartella colori

Brown walnut ash

### **Available in:**

Ash, Oak, Chestnut,  
Toulipier  
Colors and details consult  
the color chart







MOD. DANTE

Frassino noce bruno

**Disponibile in:**

Frassino, Rovere, Castagno,  
Toulipier

Colorazioni e dettagli consultare  
la cartella colori

Brown walnut ash

**Available in:**

Ash, Oak, Chestnut,  
Toulipier

Colors and details consult  
the color chart



**Coprifili e complementi scorniciati su richiesta**

Moldings and unframed accessories on request



## MOD. ISMAELE

Frassino noce bruno

### Disponibile in:

Frassino, Rovere, Castagno,  
Toulipier  
Colorazioni e dettagli consultare  
la cartella colori

Brown walnut ash

### Available in:

Ash, Oak, Chestnut,  
Toulipier  
Colors and details consult  
the color chart



## MOD. LEDA

Frassino noce bruno

### Disponibile in:

Frassino, Rovere, Castagno,  
Toulipier  
Colorazioni e dettagli consultare  
la cartella colori

Brown walnut ash

### Available in:

Ash, Oak, Chestnut,  
Toulipier  
Colors and details consult  
the color chart





## MOD. DALILA

Frassino noce bruno

### **Disponibile in:**

Frassino, Rovere, Castagno,  
Toulipier  
Colorazioni e dettagli consultare  
la cartella colori

Brown walnut ash

### **Available in:**

Ash, Oak, Chestnut,  
Toulipier  
Colors and details consult  
the color chart



## MOD. MANLIO

Frassino noce bruno

### **Disponibile in:**

Frassino, Rovere, Castagno,  
Toulipier  
Colorazioni e dettagli consultare  
la cartella colori

Brown walnut ash

### **Available in:**

Ash, Oak, Chestnut,  
Toulipier  
Colors and details consult  
the color chart







MOD. CHLOE

Frassino

**Disponibile in:**

Frassino, Rovere, Castagno,  
Toulipier

Colorazioni e dettagli consultare  
la cartella colori

Ash tree

**Available in:**

Ash, Oak, Chestnut,  
Toulipier

Colors and details consult  
the color chart



## MOD. ZENO

Frassino

### Disponibile in:

Frassino, Rovere, Castagno,  
Toulipier

Colorazioni e dettagli consultare  
la cartella colori

Ash tree

### Available in:

Ash, Oak, Chestnut,  
Toulipier

Colors and details consult  
the color chart





## ILLUSTRAZIONE ACCESSORI

### Maniglie in alluminio



Mod. Milano  
Fin. Bronzo



Mod. Milano  
Fin. Argento



Mod. Dublin  
Fin. All. Satinato



Mod. Roissy  
Fin. Ottone Lucido



Mod. Roissy  
Fin. Cromo Satinato

### Kit per porte scorrevoli



**Maniglie tonde**  
**Fin. Disponibili :**  
**Ottone Lucido**  
**Cromo Satinato**



**Maniglie quadre**  
**Fin. Disponibili :**  
**Cromo Satinato**



**Serratura**  
**Fin. Disponibili :**  
**Ottone Lucido**  
**Cromo Satinato**



**Cerniera tipo**  
**Anuba**



**Cerniera**  
**regolabile**



**Cerniera a**  
**scomparsa**  
**regolabile**



**Serratura**  
**tipo patent**



**Serratura**  
**Magnetica**



# Stipiti e Profili



R/3  
Passaggio

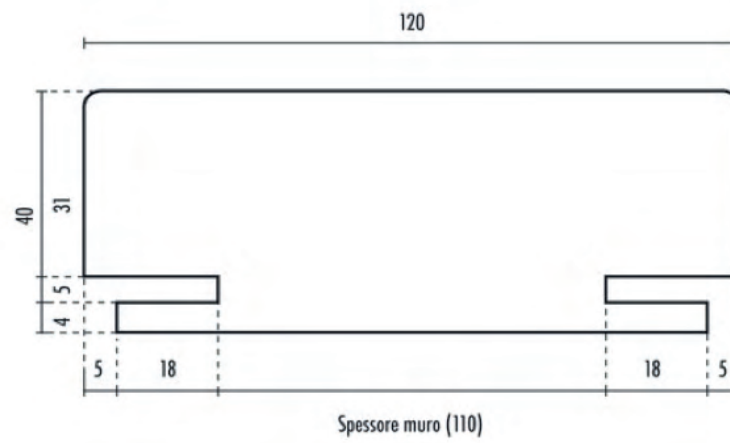

R/3

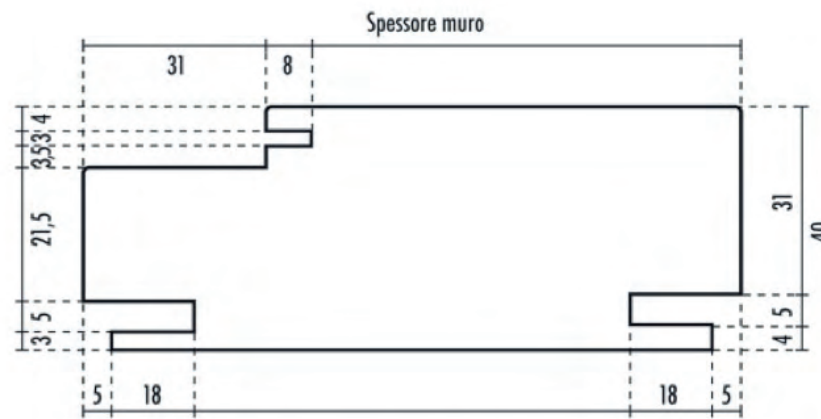





Mod. 2  
Piatto

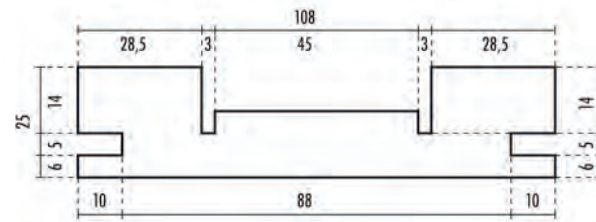
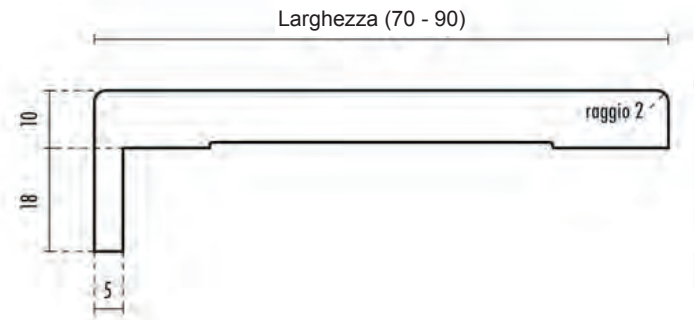

**A**  
montante telaio

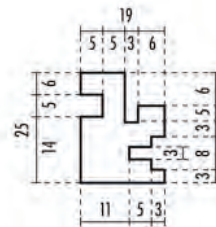

**B**  
montante battuta

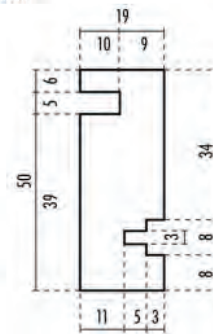

**C**  
profilo architrave





# Schema aperture

## Battente

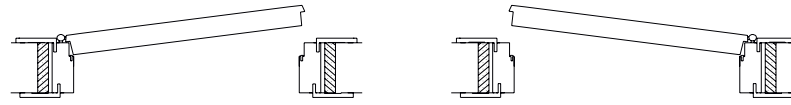

Sinistra

Destra

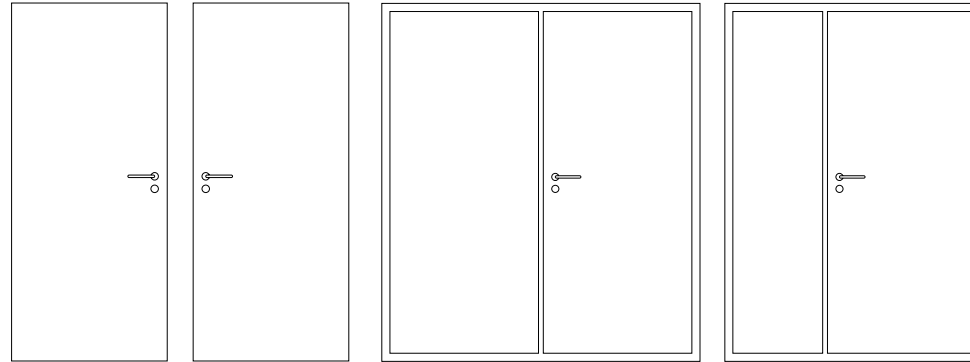

Sinistra

Destra

Doppia anta

1,5 ante

## Scorrevole

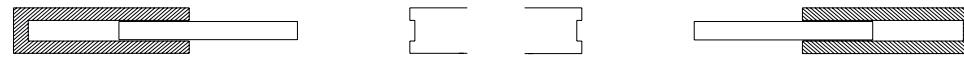

Sinistra

Destra

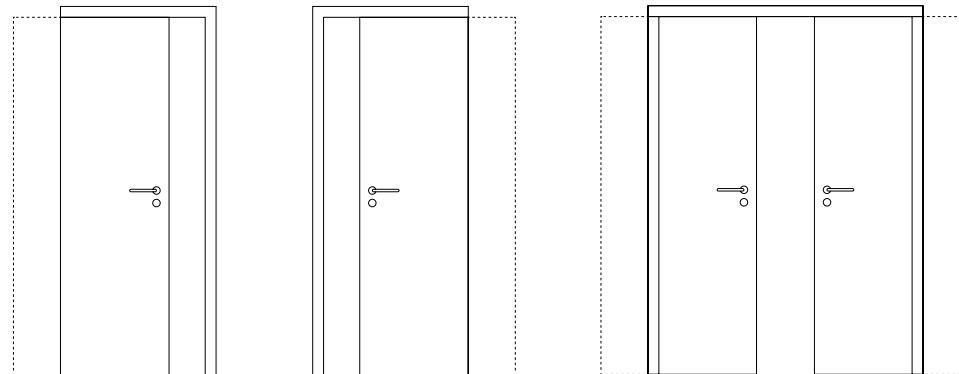

Sinistra

Destra

Doppia anta

## Libro

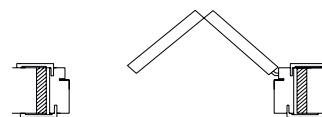

Destra

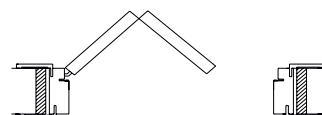

Sinistra





ALL GLASS



PLAN

divisori scorrevoli  
sliding panels

*Plan* interpreta un progetto in cui i pannelli divisori, sempre realizzati su misura, sono composti da un profilo perimetrale in alluminio di minimo spessore che valorizza al massimo le qualità estetiche dei vetri proposti da *Tema*. I divisori scorrevoli *Plan* sono stati concepiti per dividere qualsiasi ambiente domestico così come aree professionali o pubbliche.

*Plan* interprets a design system with made to measure sliding dividers, with structural profile in minimum thickness aluminium which ensures to make most of the aesthetic qualities of the glass used by *Tema*. *Plan* sliding dividers are conceptualized to separate any kind of domestic, professional and public setting.





*Plan* si colloca in una concezione estetica rigorosa di tutte le proposte della collezione *Tema*. Elemento di caratterizzazione principale è l'innovativo sistema d'installazione delle porte a battente e scorrevoli che consente una posa in opera semplice e precisa; infatti le cerniere a scomparsa e l'esclusivo stipite suddiviso in tre profilati: telaio, cornice interna e cornice esterna, permettono di effettuare un montaggio con viti completamente nascoste.

*Plan* is an aesthetic concept which is evolved from all the collections proposed by *Tema*. The main characteristic of this collection is the innovative system for simple and precise installation of both hinged and sliding doors. The concealed hinges and the exclusive frame which is divided into three sections: jamb, inner & outer casing, which makes it possible to mount the door with completely hidden screws.

PLAN

Porta a battente  
Hinged doors



PLAN

Divisori scorrevoli  
Sliding panels

La sobrietà dei divisori scorrevoli *Plan*, la varietà di soluzioni tecniche e la loro semplicità di installazione garantiscono un' ampia libertà progettuale applicabile su qualsiasi tipo di ambiente. In questa pagina divisorio scorrevole a due ante in finitura alluminio Nero con una disposizione di traversi e una composizione di diversi vetri personalizzate.

The simplicity of the sliding dividers of *Plan* system offering variety of technical solutions and the ease of installation, guarantee the freedom to create any kind of project for every type of ambience. On this page sliding divider with two panels in *Nero* aluminum finish with an arrangement of crosspieces and a composition of different customised







PLAN

Divisori scorrevoli a libro  
Sliding folding partitions

I divisori scorrevoli ad impacchettamento coniugano performance e design. Si usano per chiudere nicchie, dispense, cabine armadio o per separare ambienti unendo versatilità e valore allo spazio flessibile.

The Sliding Folding Partitions combine performance and design. They are used to close niches, pantries, walk-in closets or to separate rooms, combining versatility and value with flexible space.





GRID

Divisori scorrevoli  
Sliding panels

*Grid* è un sistema caratterizzato dal disegno dei traversi in alluminio nato principalmente per divisori scorrevoli. La prerogativa di flessibilità *Tema* dà però ampio spazio di progettazione estendendo tale disegno anche alle collezioni di porte *Plan*, *Slim* e *Edge* offrendo l'opportunità di variare lo spazio interposto tra i traversi e la possibilità di scegliere se gli stessi traversi debbano essere presenti solo su una o entrambe le facciate. Nella pagina accanto il particolare di maniglia di trascinamento ricavata dal sistema dei traversi.

*Grid* is a system characterized by aluminium cross pieces which were originally created for the sliding dividers. *Tema's* dedication to design & flexibility gives us ample possibility for creating new systems i.e. *Plan*, *Slim* & *Edge* collections, which offer the possibility of varying the space between the cross pieces as well as the option to apply the cross pieces on one or both sides of the panel. On the next page the detail of door handle integrated in the cross pieces.



GRID

Divisori scorrevoli  
Sliding panels

La versatilità di Grid consente di progettare composizioni personalizzate che delimitano gli spazi con risultati di elevata originalità. In questa pagina divisorio scorrevole a due ante che separa la camera con la cabina armadio; trave di scorrimento monorotaia a parete, struttura in alluminio finitura Piombo, vetro trasparente e traversi solo sulla facciata della camera.

The versatility of Grid allows you to create custom compositions for your space with originality. On the next page sliding divider with two panels that separate the room from the wardrobe; single sliding wall rail, Aluminium structure in Lead finish, transparent glass and cross pieces only on the side facing the room.







Porta scorrevole a scomparsa  
Sliding door with pocket system

Nelle porte scorrevoli, l'ingegnosa telescopicità dello stipite anche dal lato del cassonetto a scomparsa, annulla le differenze di spessore delle pareti consentendo una perfetta posa in opera. Nella pagina accanto porta scorrevole a scomparsa con struttura in alluminio finitura *Argento Opaco*, vetro di design *Omnidecor* modello *Bilinea* e maniglia *Clip* in alluminio nella stessa finitura della porta.

The sliding door which frame is made with such ultimate precision especially in the pocket system, that it completely eliminates the differences in the wall thickness thus allowing perfectly positioned door. On the next page sliding door with pocket system in aluminum structure with *Opaque Silver* finish, design glass by *Omnidecor* in *Bilinea*, and *Clip* handle in same finish as the door.





Porte scorrevoli a scomparsa su cassonetti senza cornici  
Sliding doors with pocket system without frame

I pannelli *Plan15* vengono utilizzati anche per porte scorrevoli installate su cassonetti a scomparsa senza cornici. Nella pagina accanto porte *Plan15* versione scorrevole a scomparsa su cassonetti senza cornici, con struttura in alluminio finitura *Nichel*, vetro *Bronzo Riflettente* e maniglie *Clip* in alluminio nella stessa finitura della porta.

*Plan15* panels are also used for sliding doors with pocket system without frames. On the next page *Plan15* sliding door with pocket system without frame, with structure in aluminium with *Nichel* finish, *Reflecting Bronze* glass with *Clip* handles in aluminium with same finish as the door.





Porta scorrevole a scomparsa  
Sliding door with pocket system

Le porte scorrevoli a scomparsa rappresentano la soluzione ideale per recuperare spazi importanti in piccoli ambienti. Il design delle porte scorrevoli *Slim* contornate da eleganti cornici di soli 38 mm di ampiezza si integra con l'ambiente e crea suggestive soluzioni. In questa pagina porta scorrevole a scomparsa a doppia anta con struttura in alluminio finitura *Argento Opaco*, vetro *Opalino extrachiaro* e maniglia *Clip* in alluminio nella stessa finitura della porta.

The sliding doors with pocket system are an ideal solution to recover important spaces in small environments. The design of the *Slim* sliding doors surrounded by elegant frames of only 38 mm in width which seamlessly integrates with any environment and creates refined solutions. On this page: Pocket system sliding door with two panels with *Argento Opaco* finish aluminum structure, *Opalino extrachiaro* glass and aluminum *Clip* handle in the same finish as the door.





Maniglia senza serratura  
Passage handle



Maniglia con nottolino  
Privacy handle

SLIM

Porta scorrevole a scomparsa  
Sliding door with pocket system





AXIS

Maniglia con nottolino  
Privacy handle



AXIS

Maniglia tema modello axis  
Handle tema model axis

La maniglia Tema modello AXIS by designer DGP e il nuovo adattatore orizzontale sono realizzati in alluminio della stessa lega dei profilati della porta al fine di ottenere le stesse finiture. L'innovazione tecnica ed estetica dell'adattatore consentono di montare la maniglia senza rosette mantenendone nel tempo una perfetta posizione orizzontale conferendo a tutto il blocco maniglia leggerezza e valore aggiunto che non passano inosservati.

The Tema model AXIS handle by designer DGP and the new horizontal door handle adapter plate are made of aluminum of the same alloy as the door profiles in order to obtain the same finishes. temps. Cette innovation apporte à l'ensemble du bloc poignée une légèreté et une valeur ajoutée qui ne passent pas inaperçues. The technical and aesthetic innovation of the door handle adapter plate allows the handle to be mounted without rosettes, maintaining a perfect horizontal position over time, giving the whole handle block lightness and added value that do not go unnoticed.

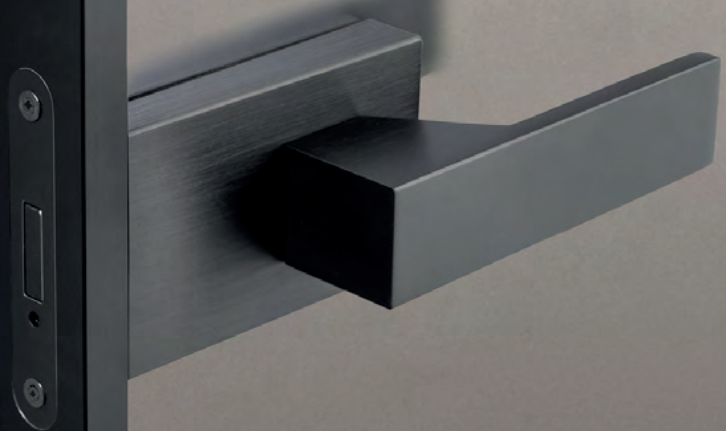

Maniglia senza serratura  
Passage handle



Maniglia con cilindro  
chiave  
Keyed cylinder handle





## PLAN

### Porta a bilico Pivot door

*Plan* nella versione a bilico, consente di immaginare nuove possibilità progettuali là dove i vani sono troppo grandi per porte a battente e non sufficientemente spaziosi per porte scorrevoli. La porta a bilico può essere dotata di apertura bidirezionale: ovvero apribile sia a spingere che tirare. Le cerniere a scomparsa superiore e inferiore possono essere decentrate a seconda delle esigenze richieste. La porta può essere dotata di cerniere tradizionali (libere) o cerniere oleodinamiche con chiusura automatica. In questa pagina porta a bilico con struttura in alluminio in finitura *Testa di Moro*, vetro *Bronzo Trasparente* e adattatore rettangolare per maniglie tradizionali in alluminio nella stessa finitura della porta.

*Plan* in pivot version enables to envision new possibilities & create projects for spaces that are too big for hinged doors and which are not spacious enough to use sliding doors. The pivot doors can be adapted to open in both directions i.e. it can be both pushed & pulled. The upper and lower concealed hinges can be positioned according the requirement. The door can be equipped with traditional (unrestricted) hinges or hydraulic hinges with an automatic closing. On the next page pivot door with aluminum structure with *dark brown finish*, *transparent glass in Bronze* and rectangular adapter for traditional handles in aluminum with same finish as the door.

*Maniglia tradizionale per porte con cerniera*

*Maniglia di trascinamento per porte con cerniera automatica*

*Cerniera libera o Cerniera automatica*



SLIM

Porta a battente  
Hinged doors

Racchiuse da preziose e sobrie cornici le porte della linea *Slim* rappresentano una singolare evoluzione della collezione *Plan*. Condividono infatti con le porte *Plan* lo stesso profilo del telaio e dell'anta ma le cornici esterne ed interne sono ridotte ai minimi termini di soli 38 mm grazie alla progettazione geniale di un semplice sistema di montaggio. Nella pagina accanto porta a battente con struttura in alluminio finitura *Nichel*.

Elegantly simple and quality frames of the *Slim* line are the design evolution from the *Plan* collection. Like the *Plan* collection they have the same profile of the frame and panel but thanks to the brilliant design of a simplified mounting system the interior and exterior casings are reduced to the thickness of only 38 mm. On the opposite page, Hinged door with aluminum structure in *Nichel* finish

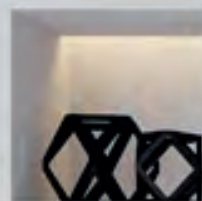



PORTA A BATTENTE  
HINGED DOOR

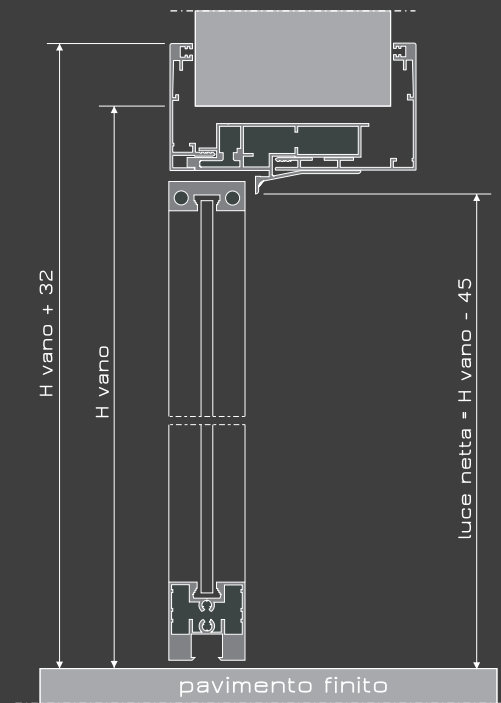
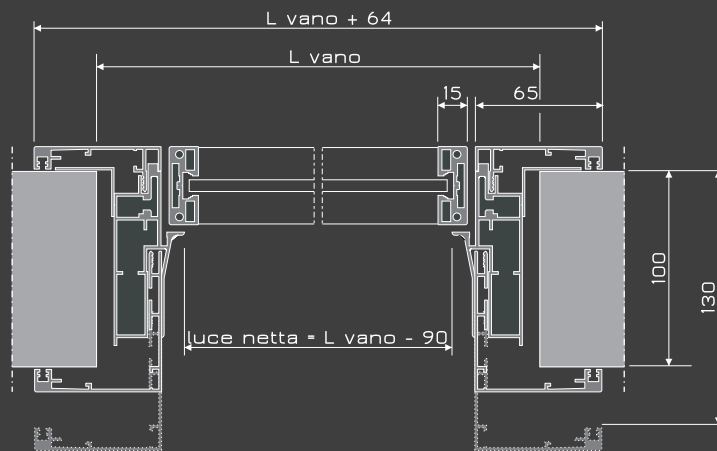

PORTA SCORREVOLE A SCOMPARSA  
SLIDING DOOR FOR POCKET SYSTEM

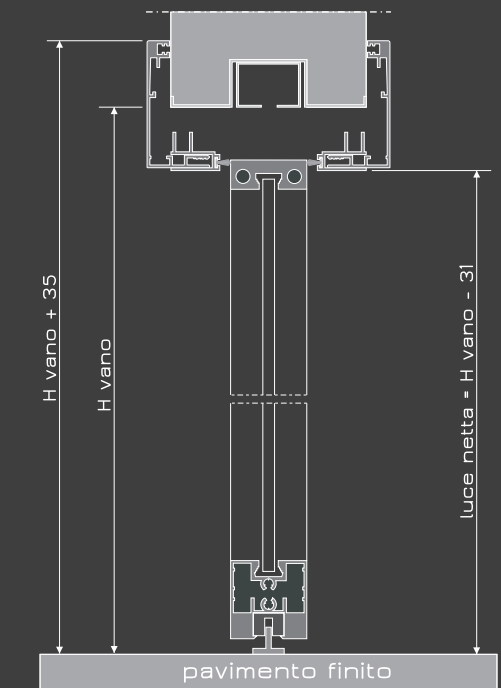
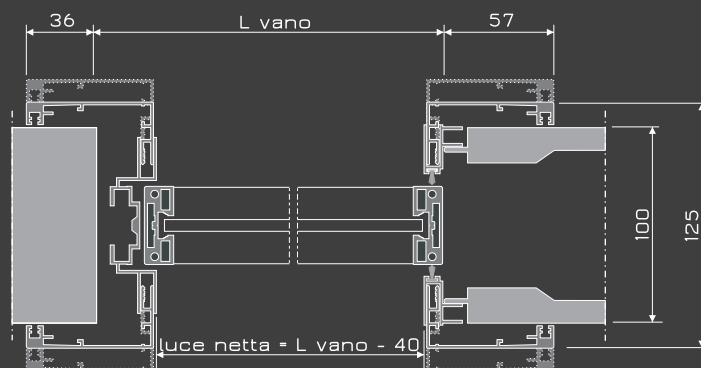



DUAL

SEZIONI PORTE - DOORS SECTION

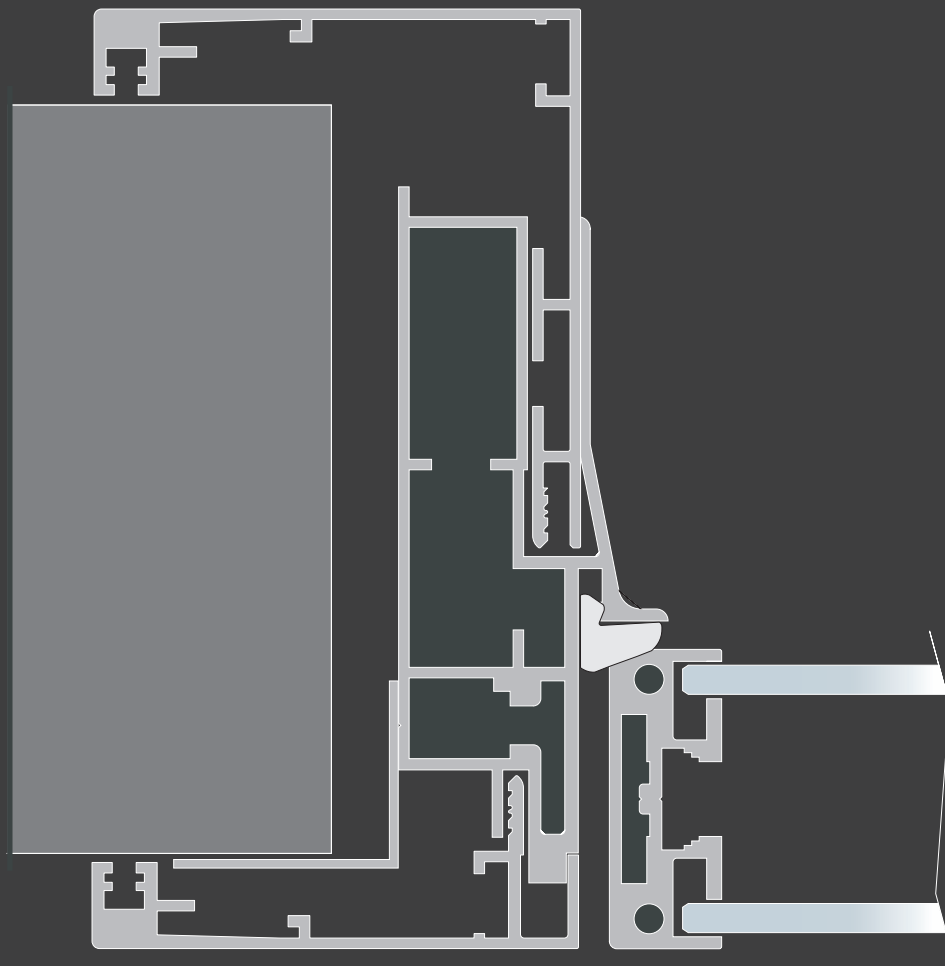



SLIM

# SEZIONI PORTE - DOORS SECTION

PORTA A BATTENTE  
HINGED DOOR

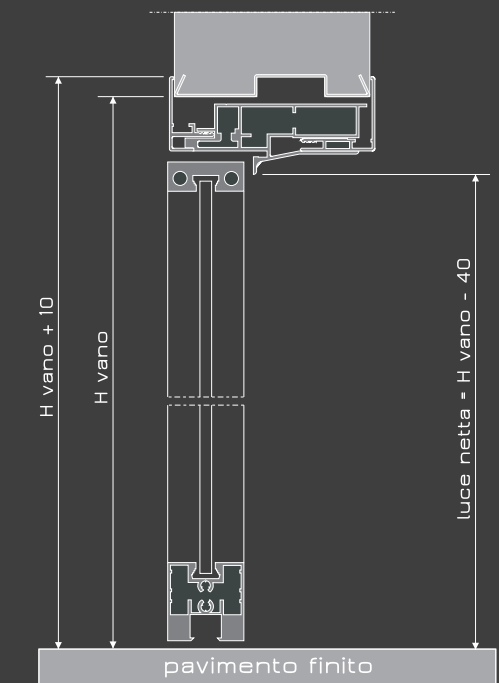
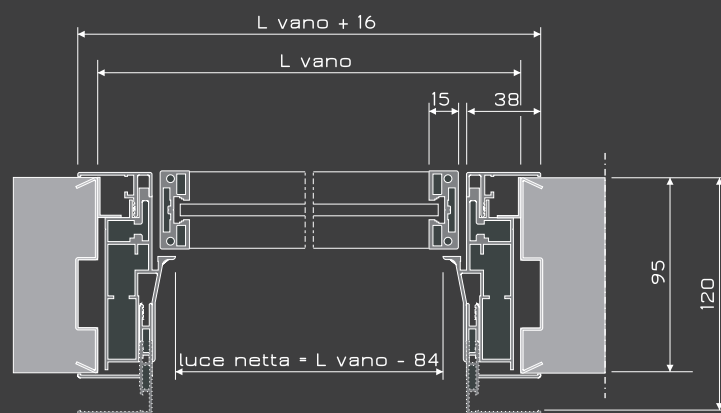

PORTA SCORREVOLE A SCOMPARSA  
SLIDING DOOR FOR POCKET SYSTEM

